

COMMONWEALTH OF MASSACHUSETTS

Profile



massachusetts alliance for economic development

MASSACHUSETTS

*We've been at technology's edge since
the Industrial Revolution . . .*

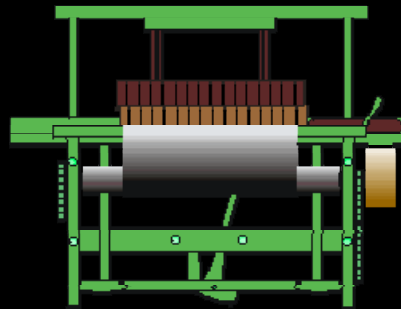

MASSACHUSETTS

*... we have the resources to help
keep your company at the edge.*



Massachusetts as a Strategic Location

Located in the *heart* of New England and



accessible to major East Coast markets.

Massachusetts Overview

- Population: 6,449,755 (2007 est.)
- Percent of Adult Population with a 4-Year College Degree or Above: 37%
- Leader in Higher Education, Health Care and Emerging Technologies

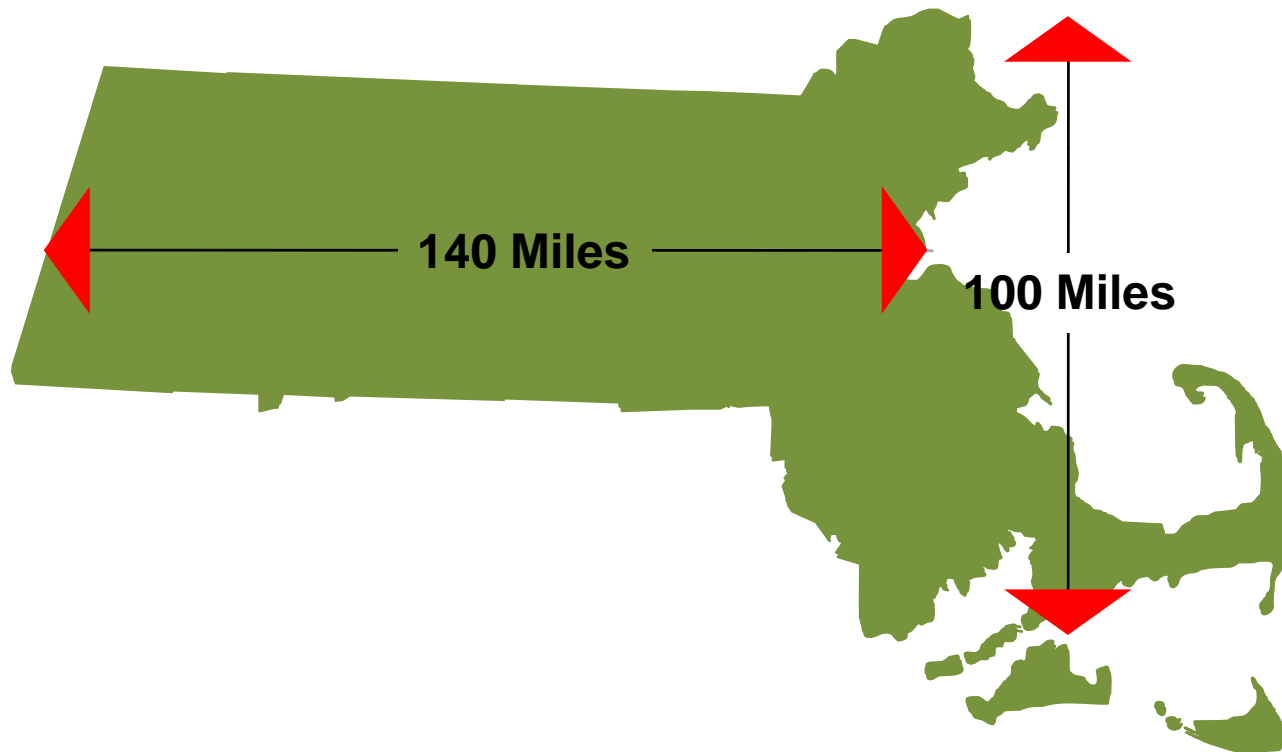

You can traverse the state very easily.

Population Concentration: Massachusetts and Adjacent States

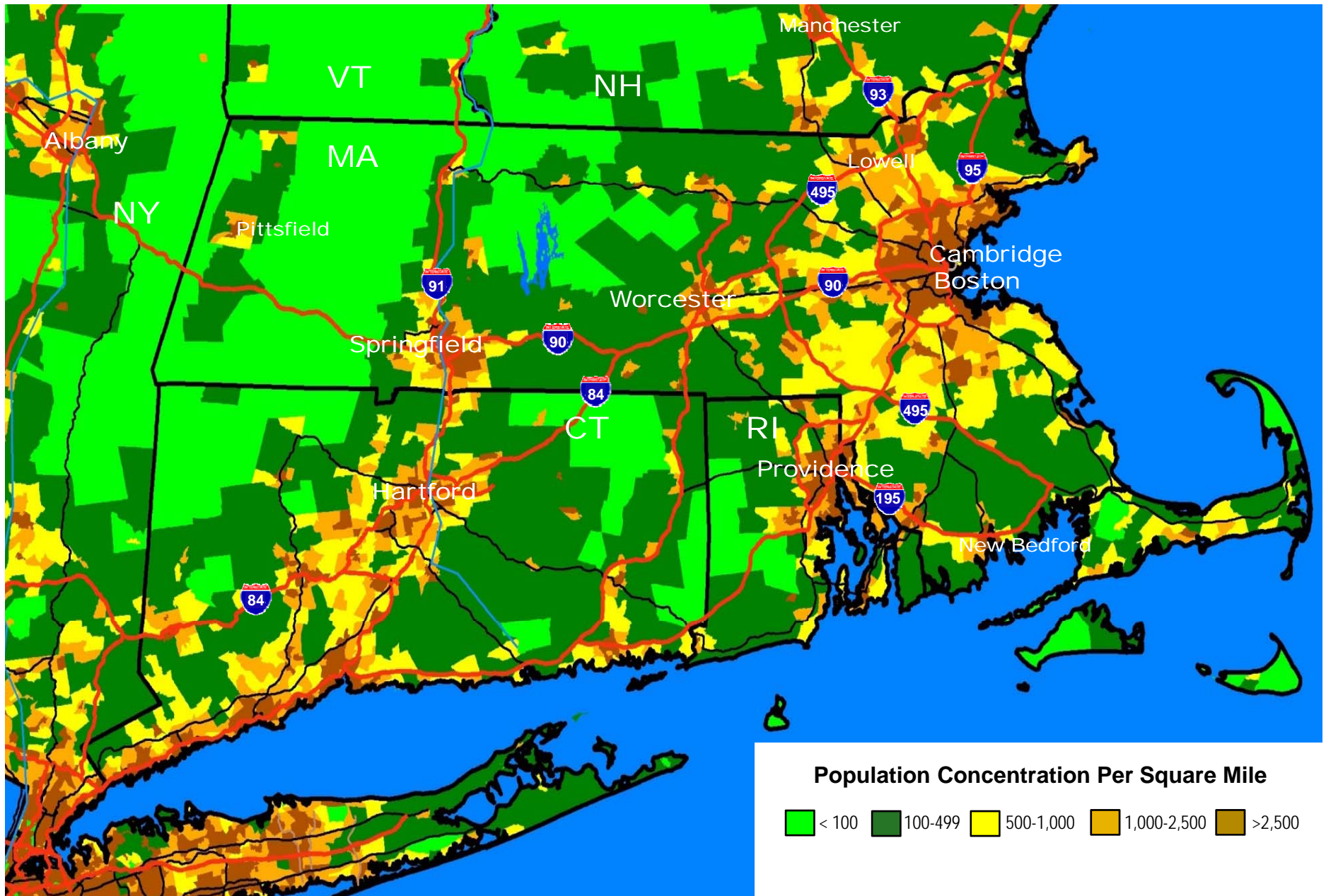

Massachusetts Economy

Diverse Economy w/ Strengths in Technology & Life Science

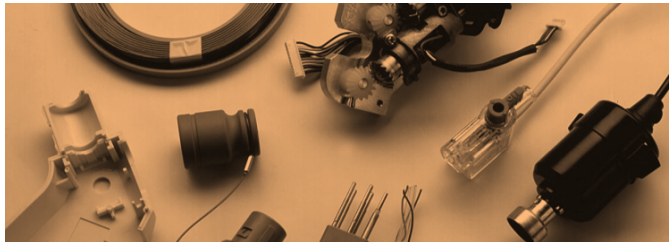
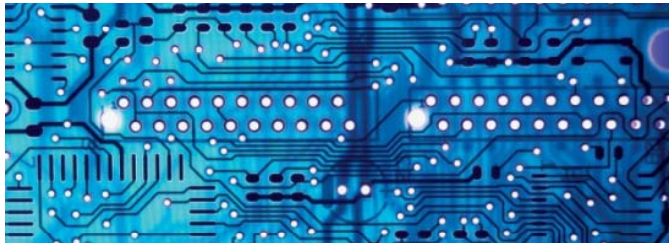

Massachusetts Economy: Key Industry Segment Employment (000)

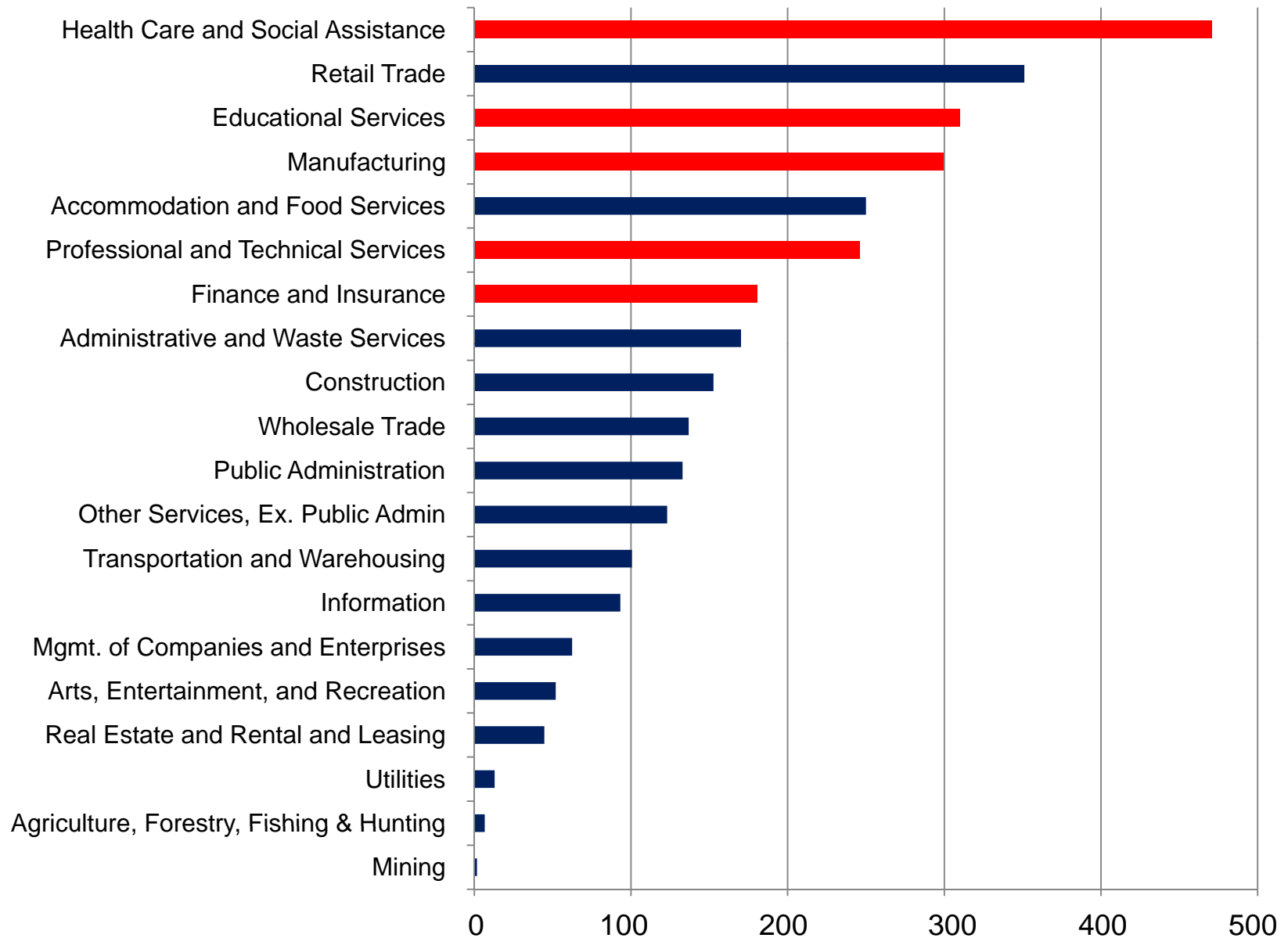

Massachusetts Economy: Key Industries and Employers



Life Sciences
 Biotechnology, Pharmaceuticals and Medical Devices
 Total Employment = 20,400

Abbott Bioresearch Center	DePuy Spine	Neurometrix
American Science & Eng'g	Five Star Surgical	Palomar Medical
Arrhythmia Research Tech.	Gentex Optical	Psychemedics
Aspect Medical Systems	Genzyme Corporation	Perkin Elmer
Avant Immunotherapeutics	Haemonetics	PolyMedica Corporation
Basilea Pharmaceutical	Harvard Bioscience	Sepracor
Biogen IDEC	Hologic	Teleflex Medical
Boston Scientific Corp.	Inverness Medical Innov.	Thermo Fisher Scientific
Bristol-Myers Squibb	Lifeline System	Waters Corporation
BrukerBioScience	Millennium Pharma.	Wyeth Pharmaceuticals
Candela Corporaton	Millipore Corporation	Zoll Medical
Charles River Labs Int'l	Norvartis	
Cytoc Corporation	Neurometrix	

Massachusetts Economy: Key Industries and Employers

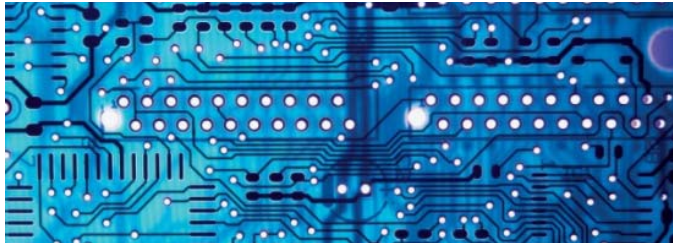

Technology
Aerospace, Defense and Computers/Electronics
Total Employment = 82,900

Analog Devices	Lockheed Martin Sippican
Avid Technology	Lucent Technology
Bose Corporation	M/A Com
BTU International	Metso Automation USA
CISCO Systems	Mitre Corporation
CMGI	MKS Instruments
Dynamics Research Corporation	Motorola
EMC Corporation	Parametic Technology Corporation
General Dynamics	Raytheon Company
Hittite Microwave Corporation	Teradyne
Iron Mountain	Varian Semiconductor Equip. Assoc.

Massachusetts Economy: Key Industries and Employers

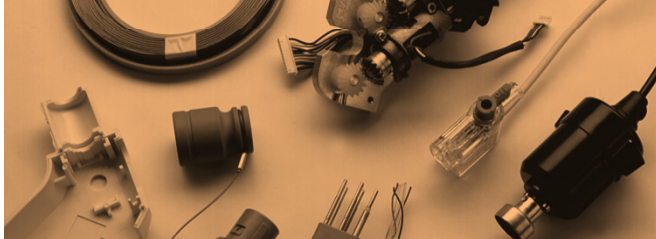

Fabricated Products
Plastics, Metals and Other Materials
Total Employment = 24,200

American Dryer Corporation	Reed & Barton
Berry Tubed Products	Simons International
Chase Corporation	Smith & Wesson
Georgia Pacific/Dixie Cutlery	Stern-Leach
International Rectifier	Sterlite Corporation
Lenox American Saw	TRW Automotive
LS Starrett Company	Wyman-Gordon Company
Nypro, Incorporated	

This industry group is comprised on many small fabrication shops located throughout the state.

Massachusetts Economy: Key Industries and Employers



Financial Services
 Banking, Investments and Insurance
 Total Employment = 181,500

Affiliated Managers Group	Independent Bank Corp
Ben Franklin Bancorp	Interactive Data Group
Berkshire Hills Bancorp	Investors Financial Service Corp.
Berkshire Life Insurance	Liberty Mutual Group
Boston Private Financial Holdings	Manulife/John Hancock
Commerce Group	MassMutual Financial Group
Eaton Vance Corp.	MFS Investment Management
Enterprise Bancorp	Safety Insurance Group
Fidelity Investments	State Street Corporation
First Marblehead Corp.	Wainwright Bank & Trust
Hanover Insurance Group	

Integrating Research With Production: Medical Devices

Massachusetts has the R&D for both product and process development as well as contract manufacturing capabilities for component production.

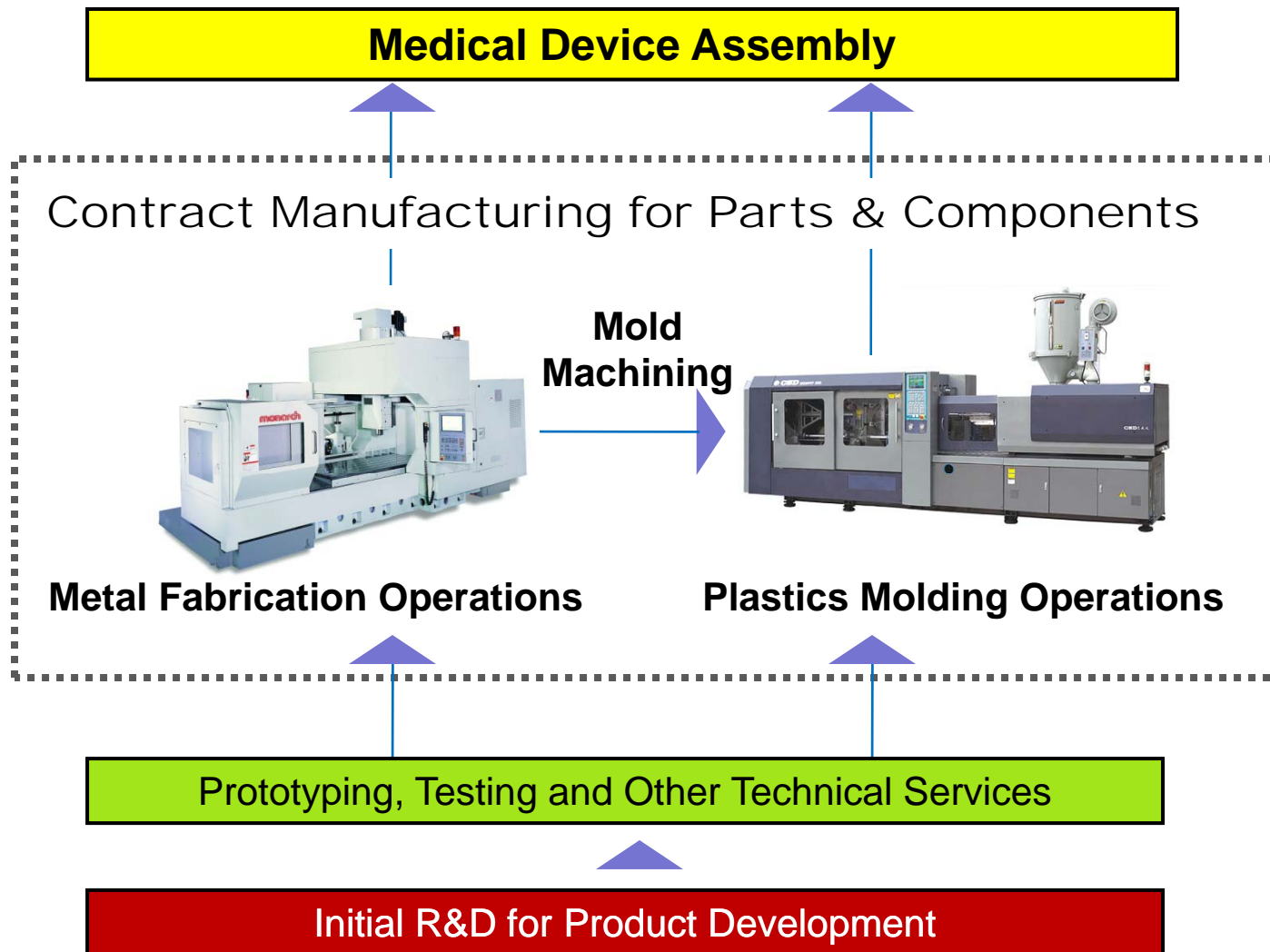

University R&D

Research Centers That Stimulate Economic Development



Major R&D Institutions Throughout the Region

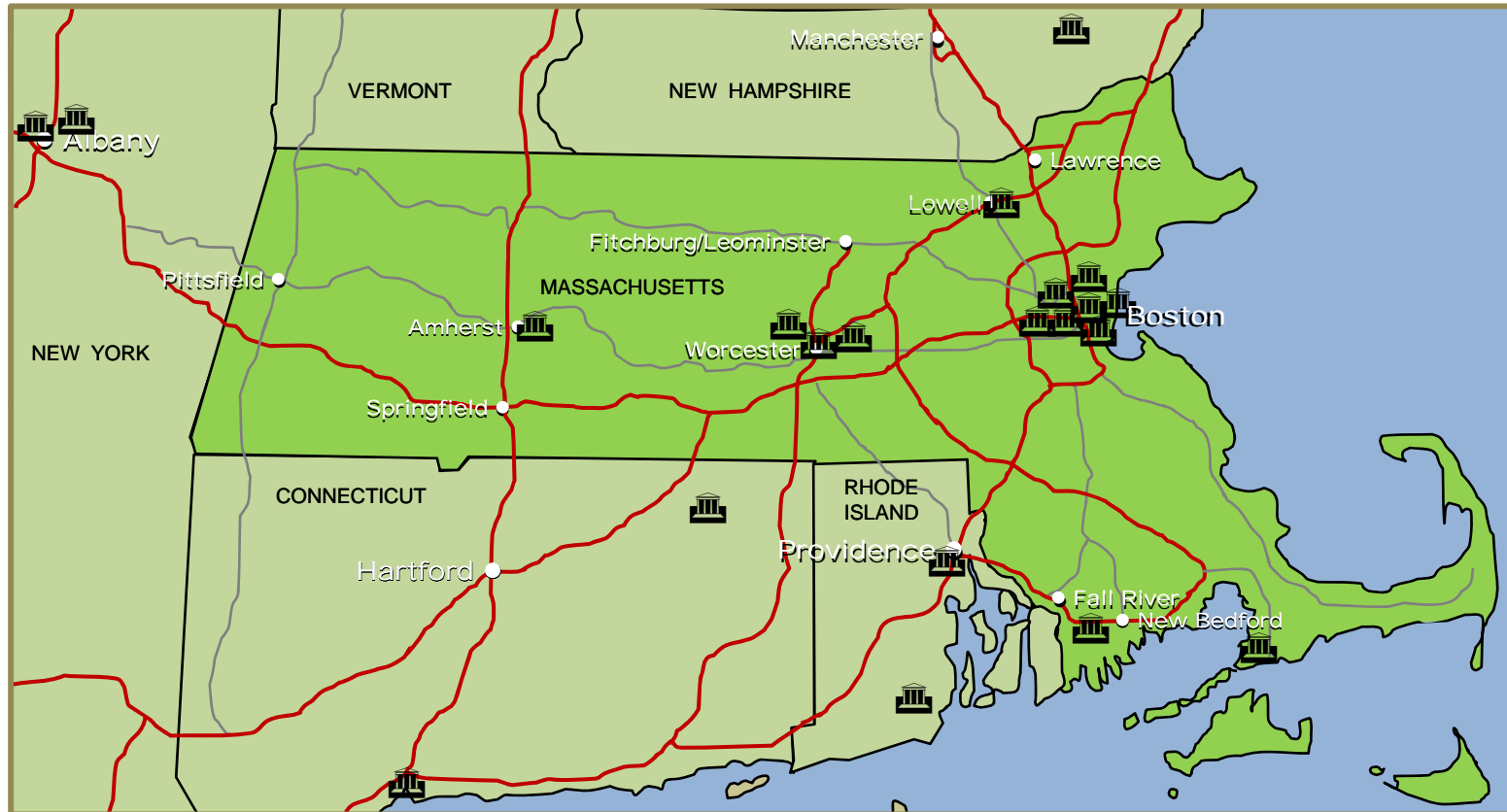

New York State

- SUNY-Albany
- RPI

Connecticut

- UConn
- Yale University

Massachusetts

- UMass Amherst
- WPI
- UMass Worcester
- Clark University
- UMass Lowell
- MIT
- Harvard University

- Boston University
- Tufts University
- Northeastern University
- Brandeis University
- UMass Boston
- UMass Dartmouth
- Woods Hole Ocean. Inst.

New Hampshire

- University of New Hampshire

Rhodes Island

- University of Rhode Island
- Brown University

University R&D: National Total and Top Ten States (\$000)

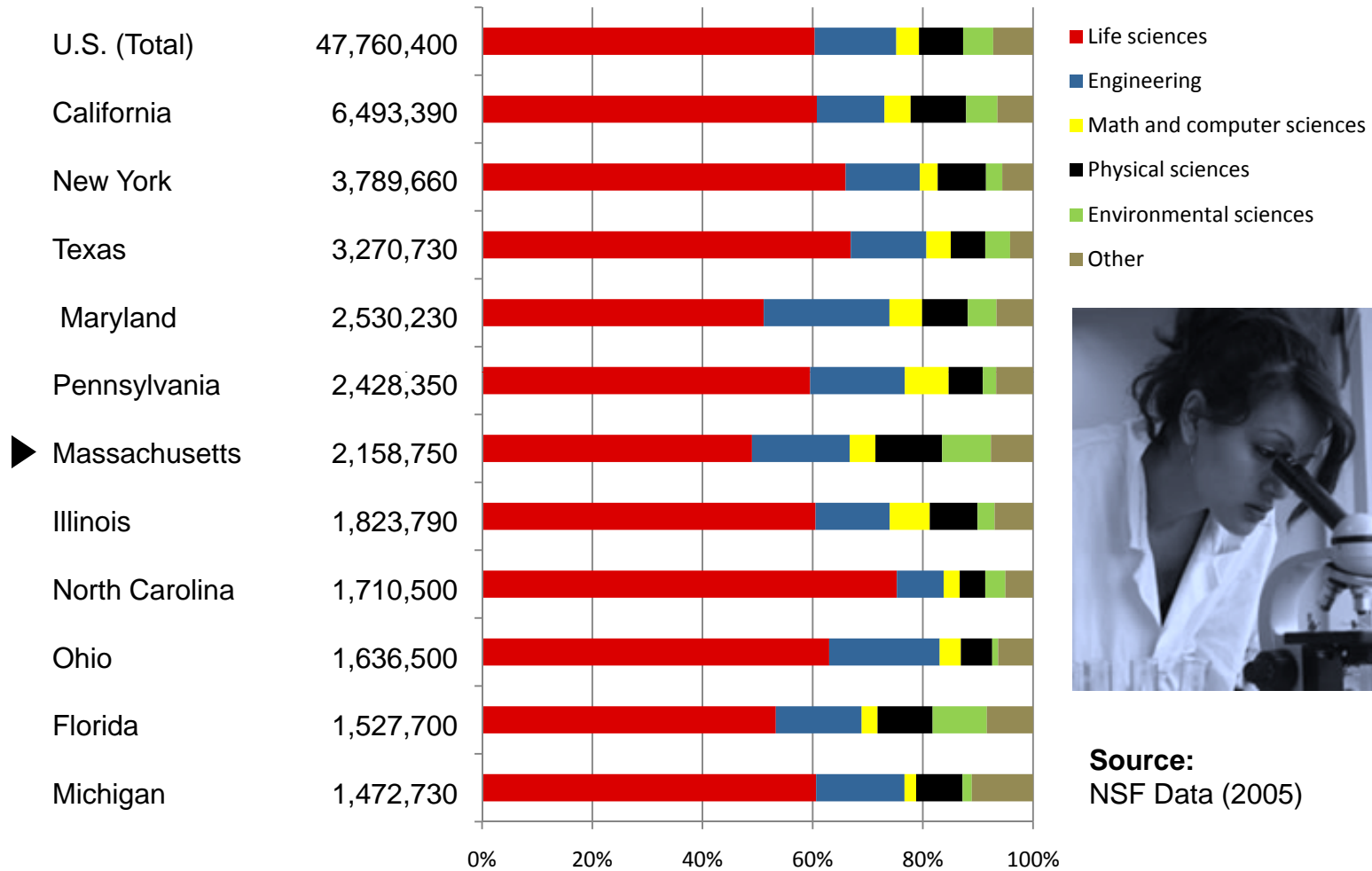

Source:
NSF Data (2005)

A top research state with a diverse program.

Massachusetts University Research: (\$000)

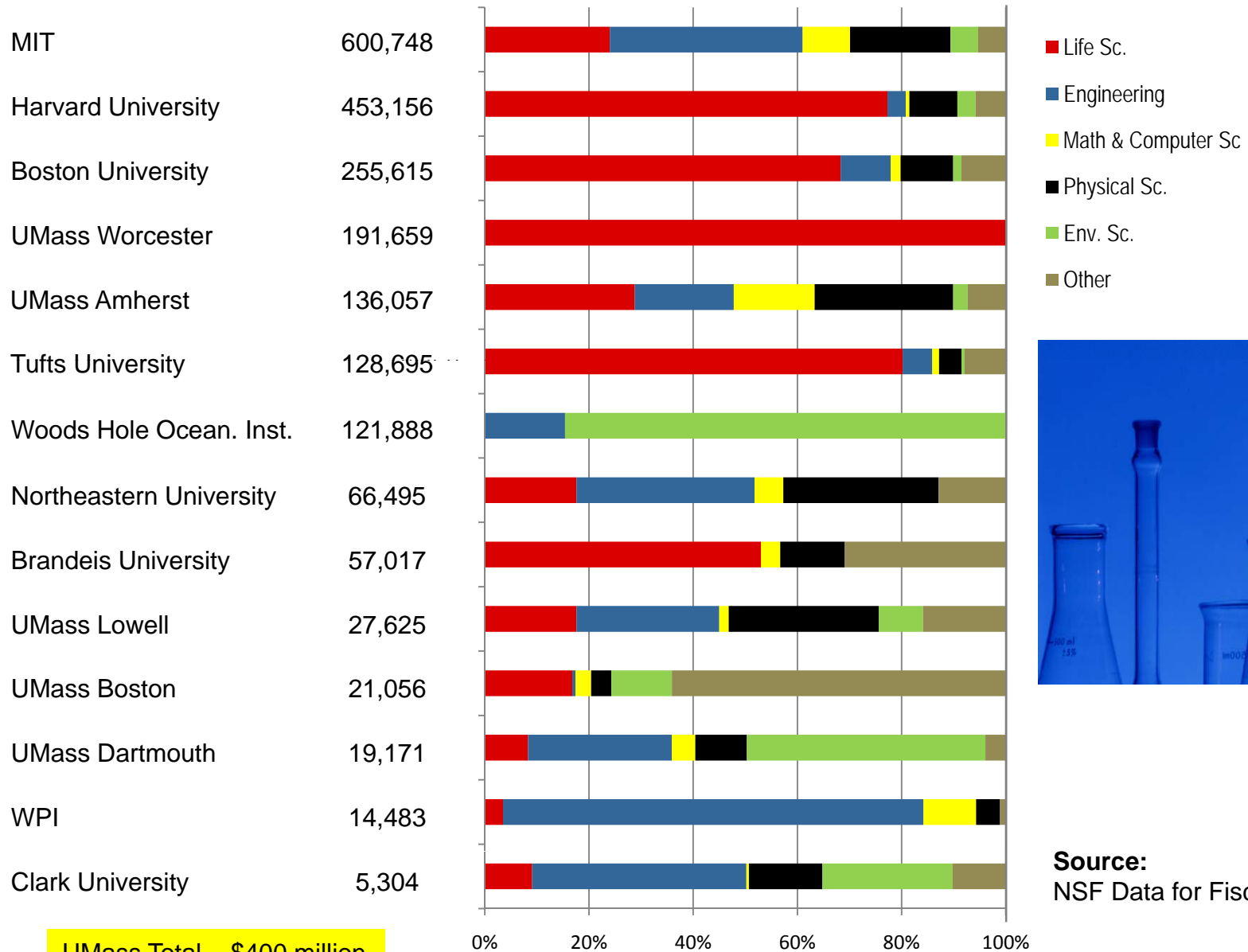

UMass Total ~ \$400 million

Source:
NSF Data for Fiscal Year 2005

Massachusetts University Research by Program Area

R&D Program Area	MIT	Harvard	Boston Univ.	UMass Worcester	UMass Amherst	Tufts Univ.	Northeastern Univ.
Life Sciences: Disease Dynamics	■	■	■	■	■	■	■
Life Sciences: Pharmaceuticals	■	■				■	■
Life Sciences: Medical Devices	■	■					
Life Sciences: Tissue/Skin/Bone Syn.	■	■		■		■	■
Life Sciences: Bioinformatics	■	■	■	■	■		
Marine Sciences	■						■
Food and Nutrition		■			■	■	
Computers/Electronics	■		■		■		■
Material Science: Polymers	■		■		■		
Material Science: Metals							
Material Science: Nanomaterials	■		■		■		■
Alternative Energy	■				■		
Aerospace/Defense/Security	■						■

Source: Websites for each institution

Massachusetts University Research by Program Area

R&D Program Area	Brandeis Univ.	UMass Lowell	UMass Boston	UMass Dartmouth	WPI	Woods Hole Ocean. Inst.	Clark Univ.
Life Sciences: Disease Dynamics		■			■		■
Life Sciences: Pharmaceuticals					■		■
Life Sciences: Medical Devices		■		■	■		
Life Sciences: Tissue/Skin/Bone Syn.			■		■		■
Life Sciences: Bioinformatics	■	■		■			
Marine Sciences			■	■		■	■
Food and Nutrition				■			
Computers/Electronics		■		■			■
Material Sciences: Polymers		■					
Material Science: Metals					■		
Material Science: Nanomaterials		■		■	■		■
Alternative Energy		■			■		
Aerospace/Defense/Security					■		■

Source: Websites for each institution

Major Colleges and Universities

Enrollment and Graduates by Selected Program



The top 20 Massachusetts' colleges and universities represent nearly 250,000 enrolled students with :

- Over 2,300 bio-related annual graduates
- Over 10,000 business annual graduates
- Over 3,200 engineering annual graduates

They also represent some of the top academic institutions in the U.S.

- Harvard University
- Massachusetts Institute of Technology
- Boston University

Colleges/Universities: Enrollment and Graduates by Selected Programs

College/University	Location	Total Enrollment	Undergrad Students	Grad Students	Bio-Related		Business		Computer/Info Sc.		Engineering	
					BS	MS/PhD	BS	MS	BS	MS/PhD	BS	MS/PhD
Boston University	Boston	31,574	18,521	13,053	216	352	706	712	54	201	264	148
Harvard University	Cambridge	25,778	9,968	15,810	154	194	0	925	25	24	25	37
UMass Amherst	Amherst	25,593	19,823	5,770	238	50	577	255	77	55	215	100
Northeastern Univ.	Boston	23,411	18,001	5,410	87	26	811	366	103	67	306	207
Boston College	Chestnut Hill	14,661	9,880	4,781	167	7	486	528	38	0	0	0
UMass Boston	Boston	12,362	9,246	3,116	95	10	361	69	27	16	0	0
UMass Lowell	Lowell	11,207	8,648	2,559	27	30	233	54	153	44	162	120
MIT	Cambridge	10,253	4,127	6,126	111	43	81	494	171	155	407	894
Salem State College	Salem	10,230	7,455	2,775	23	0	163	20	15	0	0	0
Bridgewater State	Bridgewater	9,655	7,825	1,830	40	0	176	0	26	0	0	0
Tufts University	Medford	9,638	4,995	4,643	83	46	0	13	19	32	198	91
Suffolk University	Boston	8,862	5,214	3,648	26	0	358	428	3	9	2	0
UMass Dartmouth	No. Dartmouth	8,756	7,626	1,130	43	9	324	73	35	25	79	34
Lesley University	Cambridge	6,981	1,793	5,188	0	8	45	17	0	0	0	0
Framingham State	Framingham	5,836	3,804	2,032	25	0	117	22	22	0	0	0
Bentley College	Waltham	5,555	4,296	1,259	0	0	949	475	39	21	0	0
Fitchburg State	Fitchburg	5,508	3,768	1,740	5	4	107	47	17	21	0	0
Westfield State	Westfield	5,426	4,603	823	13	0	120	0	19	0	0	0
Worcester State	Worcester	5,440	4,626	814	39	9	171	0	22	0	0	0
Brandeis University	Waltham	5,313	3,304	2,009	96	34	0	50	14	113	0	0

Source: U.S. Department of Education, Center for Education Statistics (2006-2007 school year)

Major Community Colleges: Enrollment and Graduates by Selected Programs

Community College/Vocational School	Location	Total Enrollment	Bio-Related	Business	Computer/IT	Engineering
Bunker Hill Community College	Boston	8,212	12	148	32	0
Middlesex Community College	Bedford	8,109	0	149	10	40
Massasoit Community College	Brockton	6,975	147	44	12	44
Bristol Community College	Fall River	6,927	0	130	25	39
North Shore Community College	Danvers	6,910	3	0	7	16
Northern Essex Community College	Haverhill	6,361	0	115	27	24
Holyoke Community College	Holyoke	6,297	0	157	11	20
Quinsigamond Community College	Worcester	6,022	0	114	38	60
Springfield Tech. Community College	Springfield	5,992	4	104	35	118
Massachusetts Bay Community College	Wellesley Hills	5,040	3	71	13	52
Mount Wachusett Community College	Gardner	3,937	37	11	14	5
Quincy College	Quincy	3,801	0	88	15	0
Berkshire Community College	Pittsfield	2,225	0	43	3	10
Greenfield Community College	Greenfield	2,208	0	40	4	4

Source: U.S. Department of Education, Center for Education Statistics (2006-2007 school year)

Transportation

Major Highways and Commercial Airports



Anchored by Logan International Airport in Boston as well as four very accessible regional airports



Highway system is well developed and allows same-day meetings between any location in the state.

Transportation: Major Highways and Commercial Airports

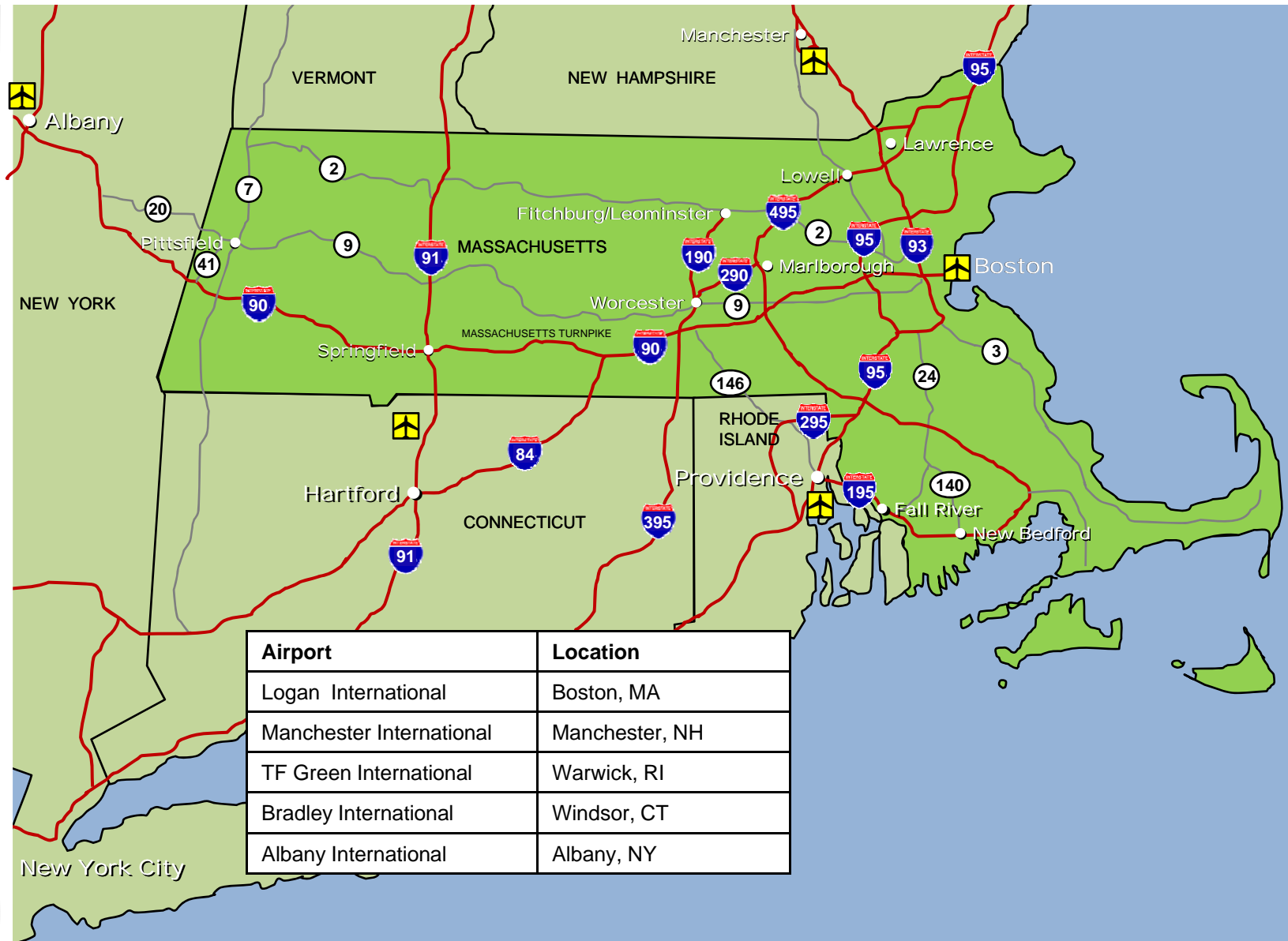

Transportation: Air Access to Strategic Cities (Domestic)

Destination	Logan Int'l	Manchester	TF Green	Bradley Int'l	Albany
Atlanta	■	■	■	■	■
Baltimore	■	■	■	■	■
Charlotte	■	■	■	■	■
Chicago	■	■	■	■	■
Cincinnati	■	■	■	■	■
Cleveland	■	■	■	■	■
Columbus	■			■	
Dallas	■			■	
Denver	■			■	
Detroit	■	■	■	■	■
Fort Lauderdale	■		■	■	
Houston	■			■	
Las Vegas	■	■	■	■	
Los Angeles	■			■	
Memphis	■				
Miami	■			■	
Minneapolis	■	■	■	■	
Nashville	■		■	■	

Transportation: Air Access to Strategic Cities (Domestic)

Destination	Logan Int'l	Manchester	TF Green	Bradley Int'l	Albany
NYC Area	■	■	■	■	■
Norfolk	■				
Orlando	■	■	■	■	■
Philadelphia	■	■	■	■	■
Phoenix	■	■	■	■	
Pittsburgh	■		■	■	■
Portland, OR	■				
Raleigh	■			■	
Richmond	■				
Salt Lake City	■				
San Diego	■				
San Francisco	■				
San Juan, PR	■			■	
San Jose	■				
Seattle	■				
St. Louis	■			■	
Tampa	■	■		■	■
Washington, DC	■	■	■	■	■
West Palm Bch	■			■	

Transportation: Air Access to Strategic Cities (Domestic)

Destination	Logan Int'l	Manchester	TF Green	Bradley Int'l	Albany
Amsterdam	■			■	
Frankfurt	■				
Halifax	■				
Keflavik (Iceland)	■				
London	■				
Milan	■				
Montreal	■			■	
Ottawa	■				
Paris	■				
Shannon	■				
Toronto	■	■		■	■
Zurich	■				

Real Estate Opportunities

Options to Meet Your Specific Needs



Real Estate Opportunities